

Diffusion

Highline 235

Modular Fan Coil Range

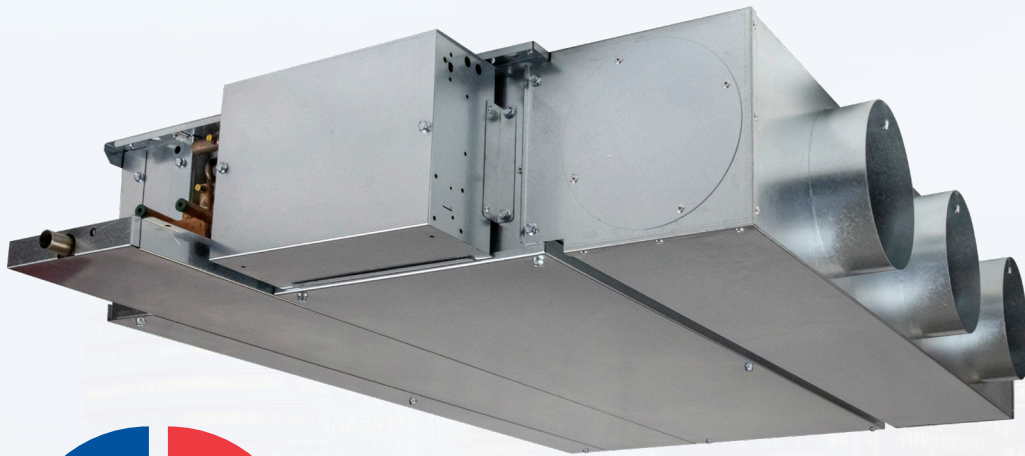

Build your project on **trust.**



CIBSE
BUILDING
PERFORMANCE
AWARDS 2024





Turn to the **experts.**

Working closely with our customers enables us to design and manufacture a diverse range of energy efficient, cost-saving Heating, Ventilation and Air Conditioning (HVAC) products that exceed expectations and Building Regulations.

The Diffusion team has in excess of 200 years of combined industry knowledge through working closely with our customers for over 60 years. This deep understanding of the project requirements has enabled Diffusion to design and manufacture the most advanced, energy efficient products that comply with all relevant Building Regulations. The team at Diffusion are ready to provide you the very best modular products that meet your exacting project requirements large or small, simple or complex, every time.



We are trusted by countless businesses across the construction supply chain having provided the best HVAC systems to hundreds of projects including Landmark buildings throughout the UK such as The Walkie-Talkie building at Fenchurch Street, The Iconic Shard and the Grade 1 Listed St Pancras Renaissance Hotel in London where hundreds of bespoke fan coil units are delivering exceptional internal thermal comfort as precisely today as they did the day they were installed.

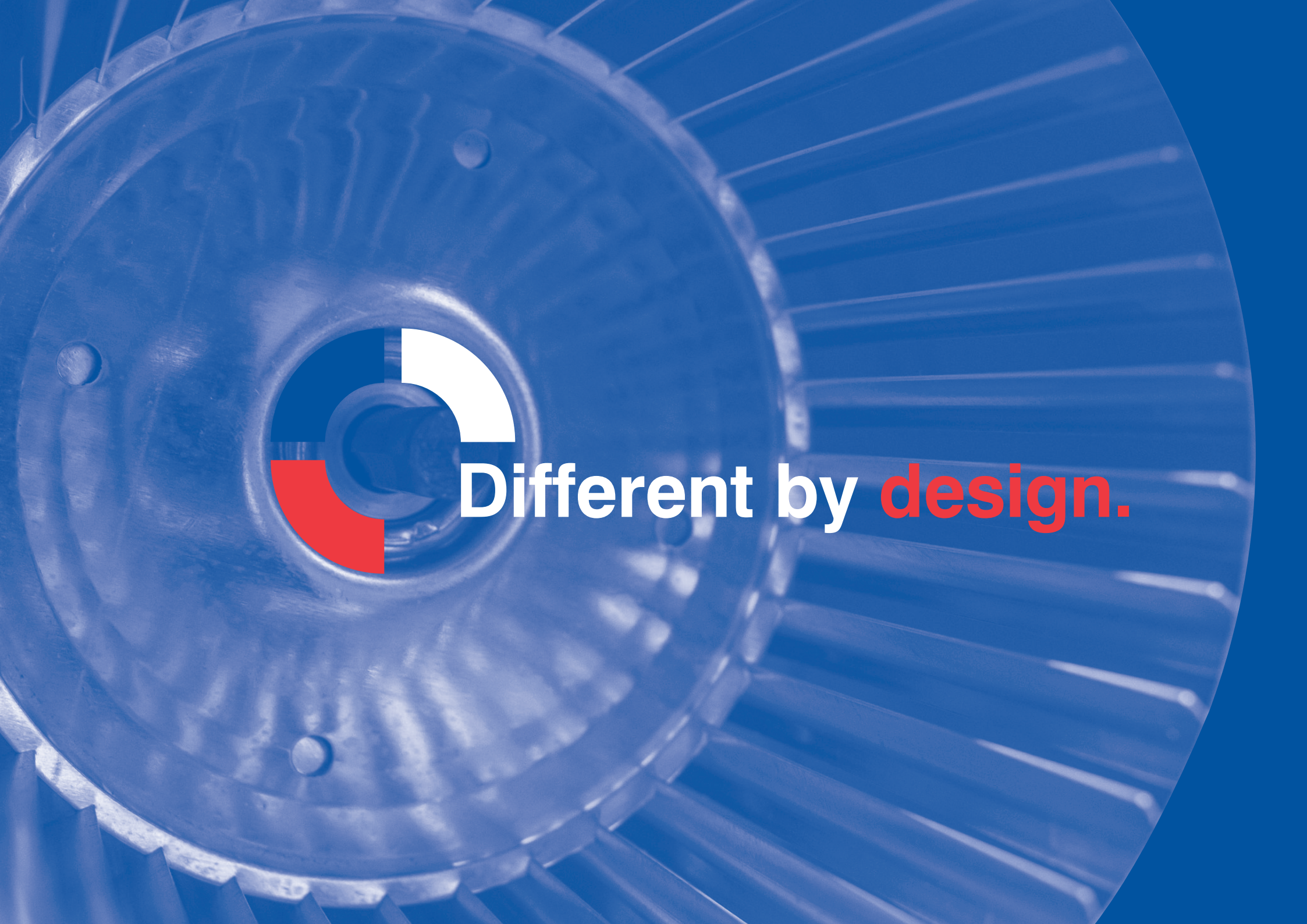

Different by design.

Product Development, Design and Test Team. Building your Project on Trust.

Having expert in-house knowledge offers countless benefits to our customers including Developers, Consultants and Contractors who can benefit from the knowledge that, not only do we have a diverse range of standard products but that we have the in-house capability to design and manufacture bespoke products for any specific project application they require.

Diffusion's facilities provide the opportunity for the client to observe the product during testing. These tests are conducted in accordance with a detailed method statement explaining each stage of the performance testing process therefore, the client can feel assured that the product will meet and

often exceed their precise project needs and be Certified in their presence. Being able to invite customers to witness the product performance prior to taking delivery of the product helps to develop relationships, trust and enhances the overall experience, providing confidence, and delivering peace of mind.

Diffusion offer an enviable range of products from standard, specialised to bespoke. They can be designed and manufactured to meet all applications in a variety of configurations, sizes and finishes to achieve customer expectations.

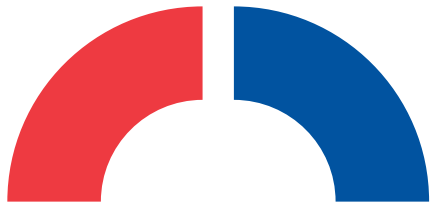

The highline range of modular fan coil units.

The Highline 235 range
is designed to create the
perfect indoor environment
at work and at home.





Innovation is at the heart of everything we do, the Highline 235 range of fan coil units is no exception. Its modular design, compact dimensions and advanced components ensure its reliable high performance.

Key Features

- 8 models including 13 fan combinations.
- Compact dimensions to suit a wide range of applications.
- Aesthetically designed for exposed or concealed applications.
- Low noise levels of NR25 to NR40 ensure it is ideal for commercial, residential and hotel applications.
- High efficiency EC/DC motor and fan assemblies provide market leading Specific Fan Power figures of just 0.14 W/ls, reducing overall building energy consumption.
- Modular design enables attenuator and plenum options to be easily configured.
- Serviceable parts freely accessible in-situ for ease of maintenance.
- Diffusion lifetime 'Eco' wire mesh filter supplied as standard or ISO grade media filters supplied as an option.
- Performance compliant with:
 - SFP - BS 8850:2020 – Fan coil unit performance. Determination of Specific fan power.
 - Airflow - BS EN ISO 5801:2017 – Fan Performance testing using standardised airways.
 - Acoustic - BS EN 16583 – Heat exchangers, hydronic room fan coil units. Determination of sound power.

Contact us today and find out how we can help with your project. Call +44 (0) 20 8783 0033 or email cooling@diffusion-group.com

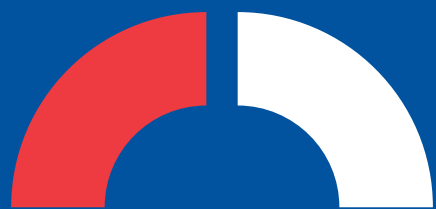

**Build your
project on trust.**

**The Highline 235: Optimum
performance, low noise
and improved efficiency.**



The new Highline 235 fan coil range offers several advantages to the customer thanks to the advanced components that deliver optimal product performance whilst reducing energy consumption and delivering lower sound levels.

Low noise levels

Noise levels of just NR25 to NR40 ensure their suitability in both residential and commercial applications including hotels.

Low specific fan power

The fan design achieves greater efficiencies delivering SFPs as low as 0.14 W/l/s.

Optimal performance

Heat exchangers specifically designed to achieve optimum heating and cooling performance using industry standard hot and chilled water temperatures.

Modular Design

Modular design delivering flexibility and reduced risk from design to installation and commissioning to maintenance.

Your design, your choice.

**The modular Highline 235
is designed to offer great
flexibility with almost 300,000
configurations to meet your
specific project needs.**

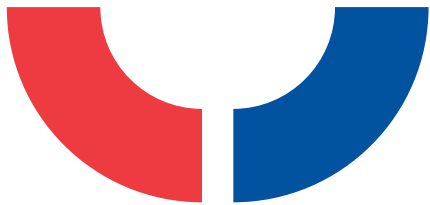

Fan Coil Product Codes: HL235B-WHCH-12/2 * FR+CP

New Highline 235 Range: Example Product Code

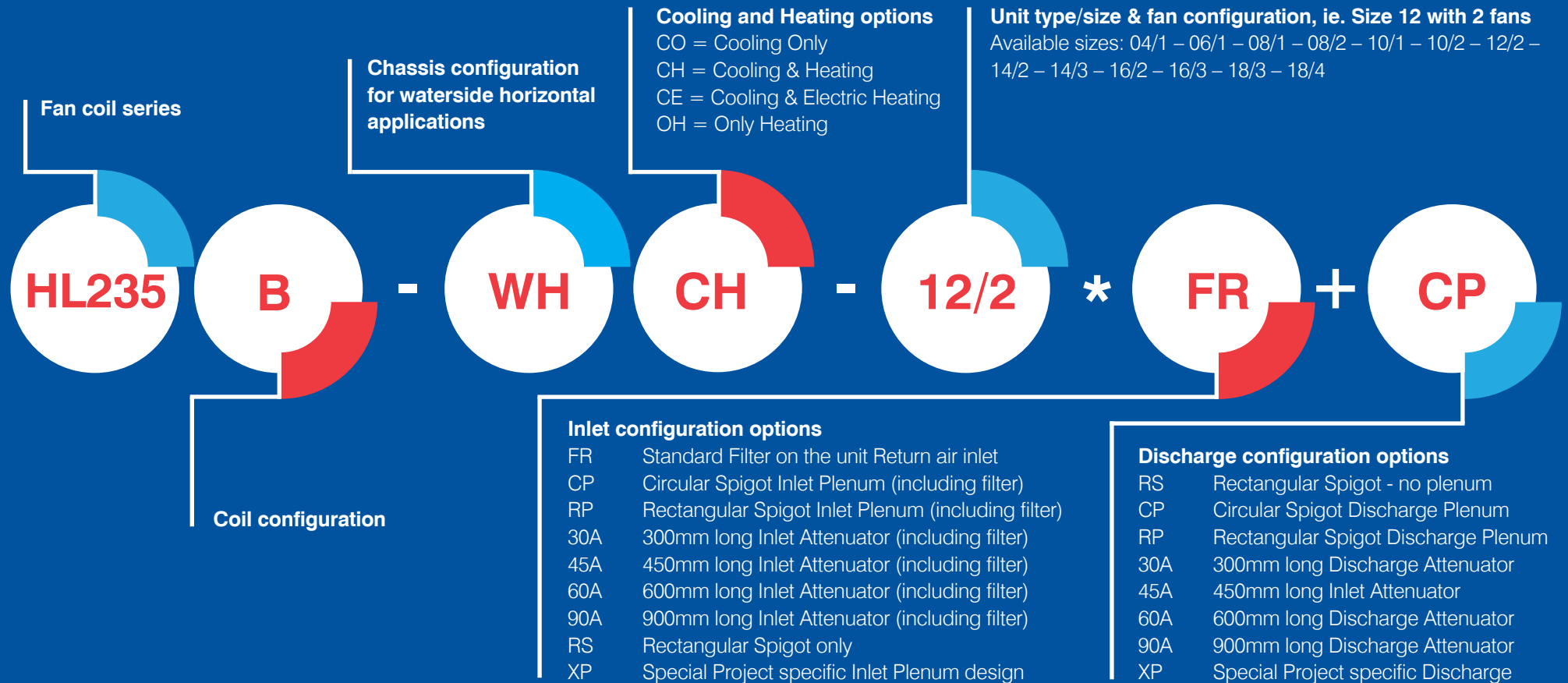

Additional fan coil unit configuration options:

Filter

- Eco filter supplied as standard, made of metal, woven fine wire mesh. Options are grades: Coarse 30% (G2) and Coarse 50% (G3) to ISO 16890.
- Filters can be split enabling easy access in installations with restricted access.
- Filters can be accessed beneath the unit or from the side of the unit for ease of maintenance.

Control Enclosure

- Standard fitted to the nominated access side of the fan coil, with remote mounting options on umbilical cabling.

Drain tray

- Units are fitted as standard with a short drain tray; and can be fitted with the optional extended length tray for PICV fitting.
- The drain connection and tray are made of stainless steel for longevity and rigidity.



Modular assembly.



Modular fan coil units ensure greater flexibility and ease of maintenance.

03 Controls enclosure, easily accessed

The controls enclosure is mounted on to the side of the unit. It can be mounted away from the unit to suit site requirements if preferred.

04 Filters, easily accessed

The filter/s are easily accessed or removed on-site either from the side of the unit or beneath the unit making cleaning easy. Larger models have split filters to further enhance maintenance. Diffusion lifetime 'Eco' wire mesh filter supplied as standard or ISO grade media filters supplied as an option.

04a Access panel to filter/s

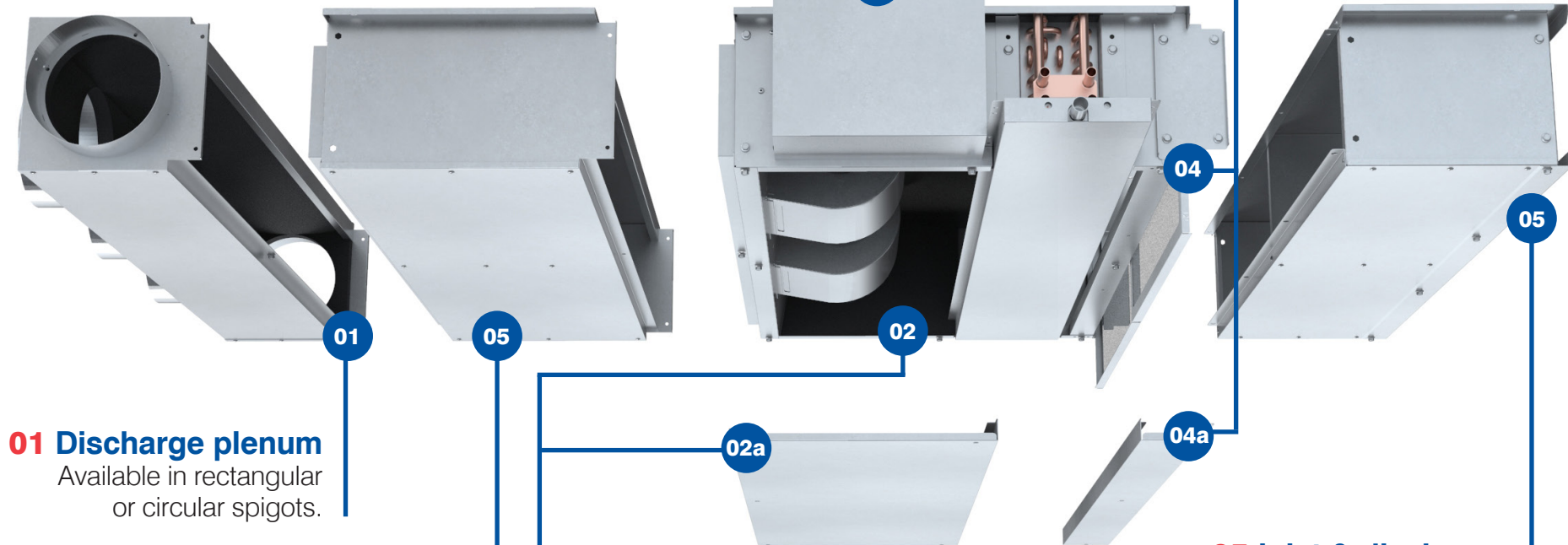

01 Discharge plenum

Available in rectangular or circular spigots.

05 Inlet & discharge attenuators

Available in different lengths to suit the specific sites acoustic requirements.

02 Core of the unit, easily accessed

The Core of the unit is designed to enclose the key components including filter, heat exchanger and fans. The core is the foundation of your selection and provides the base for the modular approach. All components are easily accessed via a full width panel for ease of maintenance.

02a Access panel to core

05 Inlet & discharge attenuators

Available in different lengths to suit the specific sites acoustic requirements.



Specification.

Sizes for all types of application.

With 8 sizes and including up to 13 fan combinations the Highline 235 is the ideal solution for many applications from hotel rooms to large capacity applications such as reception areas and offices.

The Highline 235 incorporates many components that have been designed to improve quality, enhance efficiency and overall performance of the product whilst also reducing noise levels. These design enhancements are the direct result of Diffusion's close relationships with customers and their project needs. Here are the key benefits:

Steel Chassis

All elements have been designed with product performance, ease of installation, service and maintenance in mind. Key components are easily accessed via a full width removable panel. Chassis components are made from galvanised steel sheet for increased durability. All panels are precision cut by laser and strengthened to provide a rigid, distortion free construction. The modular design features provide flexibility of product configuration and ease of use for both initial product build and future modification. Adding attenuators or plenum options is easily achieved.

Fans

Forward curved centrifugal fans are used in all models providing the most efficient airflow and acoustic performance. Fan scrolls are manufactured from galvanised steel sheet and fitted with multi-bladed aluminium or galvanised steel impellers.

Motors

Fan assemblies incorporate the latest technology. Electronically commutated direct current type motors, rated for continuous operation with inbuilt overload protection devices. Capable of performance modulation via 0 to 10 Volt dc control signal. Totally enclosed construction design with maintenance free, sealed for life ball bearings. Motors are compliant with all current EMC and electrical standards. Electrical supply requirements: 230V-1-ph-50Hz.

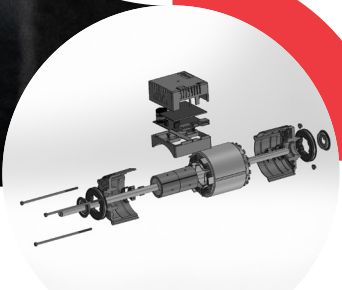

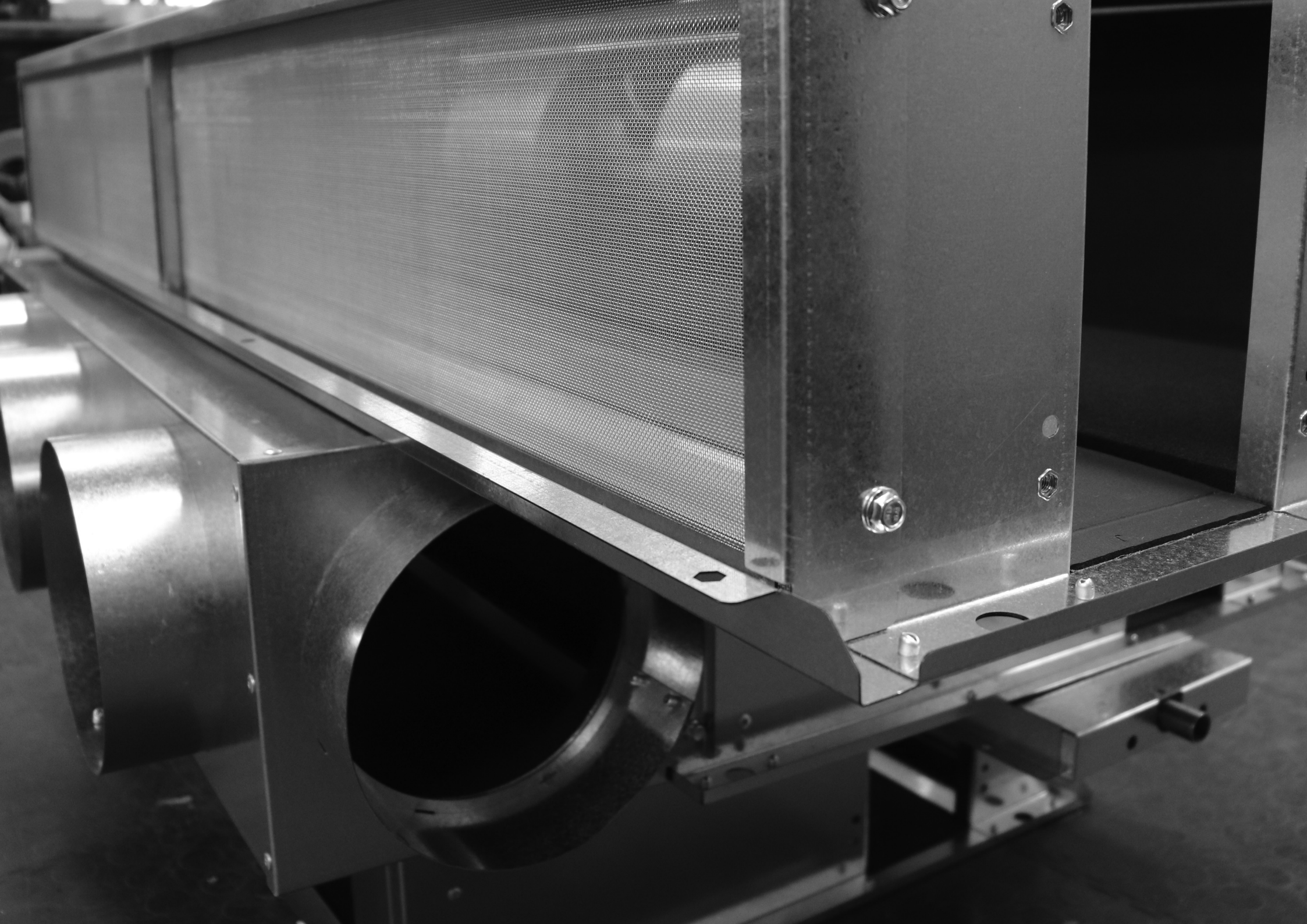

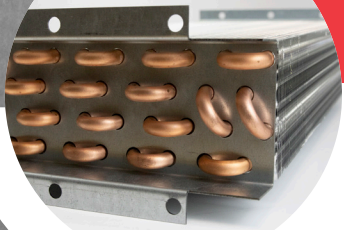

Heat Exchanger

Manufactured from solid drawn copper tubes, mechanically expanded into accurately pre-formed collars in rippled plate type aluminum fins. Incorporating multi circuit designs to ensure maximum thermal performance efficiency. Headers unifying the circuits terminate in plain tail connections on 40mm centres. The heating and cooling circuit headers incorporate manually operated key pattern air vents and drains. Heat exchangers can operate at system pressures up to 12 bar, manufacturer tested to 20 bar dry air / nitrogen under water.



Electric Elements

Electric elements are manufactured from 8mm Diameter fully sheathed stainless steel rod, with spiral wound fin for optimum heat transfer into the airflow. Overheat safety protection is provided by a manual re-set high temperature capillary type cut-out, directly wired to provide power supply isolation. A fan monitor relay is incorporated to provide additional safety, ensuring correct rotation of the motors before allowing operation of the heating elements.

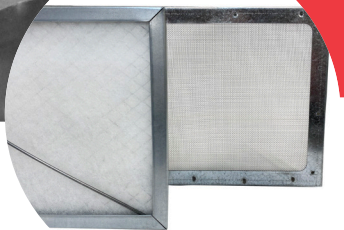

Filters

The Diffusion 'eco' filter is fitted as standard, it is a woven mesh made of fine galvanised steel wire, welded to a rigid galvanised steel support frame. The 'eco' filter is a robust and environmentally conscious solution that can be vacuum cleaned whilst fitted to the fan coil. The filter/s can be easily removed from either side of the unit, or from below. Split filters on larger units are coupled together for ease of removal from all withdrawal orientations. Synthetic media filter options to grade ISO Coarse 30% and 50% are available.



Insulation

The HL235 fan coils are insulated throughout with class "0" fire rated foam, precision cut and bonded to the unit panels with a modified acrylic adhesive. The thickness of the insulation throughout the unit varies to ensure superior thermal and acoustic performance, 70% is either 12 or 25mm thick.



Condensate Drip Trays

Drip trays are manufactured from stainless steel sheet with a 22mm diameter stainless steel drain connection, the assembly is TIG welded on all joints and insulated with class “0” fire rated foam. The external section of the drip tray is fitted with a void tray to aid the removal of condensate and stop large debris from entering the drain line. An extended drain tray option is available, providing cover and a means of support for PICV assemblies with integral flushing loop. The entire drain tray assembly is easily removable to facilitate maintenance and cleaning.

Controls Enclosures

Fan coils are supplied fitted with a control enclosure providing appropriate mounting and protection for controllers and control equipment. Pre-configured to allow incoming wiring for power and peripheral devices, all internal wiring configured with tri-rated cable to the latest electrical standards.

Quality Testing

When assembly is completed each fan coil is subjected to a thorough mechanical examination. Fan run and speed modulation is checked, controls operation/functionality is checked when possible, and electrical safety checked. Heat exchanger and valve assemblies are pressure decay leak tested. Having successfully passed all testing as detailed and in accordance with our quality standards procedures the finished unit is ready for packing and dispatch.

Condensate Pump

For condensate pump requirements Diffusion provide the MAXIBLUE rotary diaphragm pump. Using patented sensing technology and diaphragm design, this solution offers virtually silent operation and unrivaled performance for condensate removal. Pump and sensing reservoir are mounted to the HL235 fan coil with bespoke metalwork providing a robust and aesthetic solution; for both factory build and retro-fitting.



Entering Air Design Conditions:			Cooling Design Conditions:			Heating Design Conditions:		
Season	Temperature	Temperature	Flow/Return Temp.	Flow/Return Temp.	Flow/Return Temp.	Flow/Return Temp.	Flow/Return Temp.	Flow/Return Temp.
Summer	23.0 db °C	16.2 wb °C						
Winter	21.0 db °C		6/12 °C	8/14 °C	10/15 °C	80/60 °C	60/40 °C	45/40 °C
External system static pressure		30 Pa						

Model Reference	Airflow / NR Guide / SFP			Cooling Output				Heating Output				
	Airflow l/s	Ind. Unit Guide NR	SFP W/l/s	Sensible Duty Watts	Total Duty Watts	Sensible Duty Watts	Total Duty Watts	Sensible Duty Watts	Total Duty Watts	Sensible Duty Watts	Sensible Duty Watts	Sensible Duty Watts
HL235B-WHCH-04/1 * FR+CP	74	30	0.19	985	1209	810	905	734	2345	1348	642	610
	108	35	0.25	1371	1650	1133	1253	1021	1089	1695	703	769
	140	40	0.35	1700	2011	1410	1553	1274	1356	1980	740	890
HL235B-WHCH-06/1 * FR+CP	89	30	0.20	1306	1675	1103	1275	984	1064	1800	754	802
	136	35	0.27	1878	2342	1597	1814	1423	1529	2337	863	1045
	184	40	0.40	2395	2908	2042	2288	1817	1943	2775	1109	1247
HL235B-WHCH-08/1 * FR+CP	112	30	0.21	1541	1918	1228	1372	1128	1206	2418	1070	1074
	170	35	0.34	2255	2762	1871	2093	1686	1803	3134	1464	1394
	191	40	0.42	2485	3016	2072	2310	1860	1988	3350	1566	1488
HL235B-WHCH-08/2 * FR+CP	102	30	0.17	1405	1751	1751	1296	1023	1094	2280	992	1016
	190	35	0.22	2475	3006	3006	2306	1852	1978	3340	1570	1490
	254	40	0.30	3139	3738	3738	2914	2365	2521	3960	1884	1762
HL235B-WHCH-10/1 * FR+CP	125	30	0.20	1873	2425	1557	1803	1401	1517	2888	1418	1278
	175	35	0.30	2524	3211	2135	2456	1909	2060	3568	1778	1588
	202	40	0.40	2854	3593	2429	2782	2163	2329	3919	1961	1735
HL235B-WHCH-10/2 * FR+CP	102	30	0.16	1543	2015	1259	1460	1141	1238	2570	1242	1136
	200	35	0.20	2803	3534	2376	2723	2109	2271	3897	1958	1728
	310	40	0.29	3974	4832	3359	3764	2973	3178	5004	2534	2234
HL235B-WHCH-12/2 * FR+CP	144	30	0.15	2123	2729	1698	1931	1552	1673	3213	957	1435
	237	35	0.20	3357	4233	2831	3235	2530	2723	4397	1129	1973
	370	40	0.33	4843	5896	4124	4625	3670	3924	5661	2061	2541
HL235B-WHCH-14/2 * FR+CP	169	30	0.14	2611	3432	2182	2568	1957	2134	3843	1127	1715
	255	35	0.20	3768	4848	3206	3729	2862	3100	4971	1881	2221
	354	40	0.26	4935	6180	4235	4840	3761	4046	6019	2563	2691
HL235B-WHCH-14/3 * FR+CP	162	30	0.18	2488	3276	2070	2437	1853	2021	3748	1110	1664
	290	35	0.23	4150	5291	3533	4085	3135	3387	5388	2178	2408
	402	40	0.34	5382	6682	4583	5199	4041	4335	6487	2829	2903
HL235B-WHCH-16/2 * FR+CP	202	30	0.16	2775	3453	2109	2332	2010	2149	4589	1821	2035
	310	35	0.22	4154	5113	3448	3865	3103	3319	6014	2724	2684
	380	40	0.27	4921	5963	4126	4602	3703	3957	6749	3129	3009
HL235B-WHCH-16/3 * FR+CP	200	30	0.17	2717	3379	2044	2258	1952	2087	4557	1798	2028
	356	35	0.24	4595	5595	3825	4275	3424	3660	6510	2996	2898
	470	40	0.34	5718	6829	4790	5303	4259	4541	7640	3610	3410
HL235B-WHCH-18/3 * FR+CP	243	30	0.18	3485	4422	2881	3283	2599	2799	5441	2499	2415
	387	35	0.24	5240	6481	4444	5014	3968	4251	7285	3537	3241
	512	40	0.33	6558	7916	5586	6237	4969	5308	8543	4265	3809
HL235B-WHCH-18/4 * FR+CP	177	30	0.16	2558	3272	1979	2227	1833	1969	4489	1901	1985
	340	35	0.19	4653	5809	3915	4440	3493	3751	6738	3238	2998
	514	40	0.26	6464	7799	5482	6120	4860	5191	8565	4279	3817

All sizes in the HL235 range have been independently acoustic tested across their performance envelope to establish the combined inlet and case radiated, discharge duct radiated, and in-duct sound power levels; testing was undertaken at SRL (Sound Research Laboratories) and conducted in accordance with BS EN 16583:2015. Diffusion NR guide figures have been calculated using our established acoustic modelling process, with calculations and allowances as detailed in CIBSE Guide B4:2016. Volumetric flow rates for all units determined on our, BS EN ISO 5801:2017, airflow measurement bench, detailing SFP figures in accordance with BS EN 8850:2020 with ISO coarse 30% filters to BS EN ISO 16890-3. Full NR guide details available on request.

Highline HL235-WH - General arrangements.

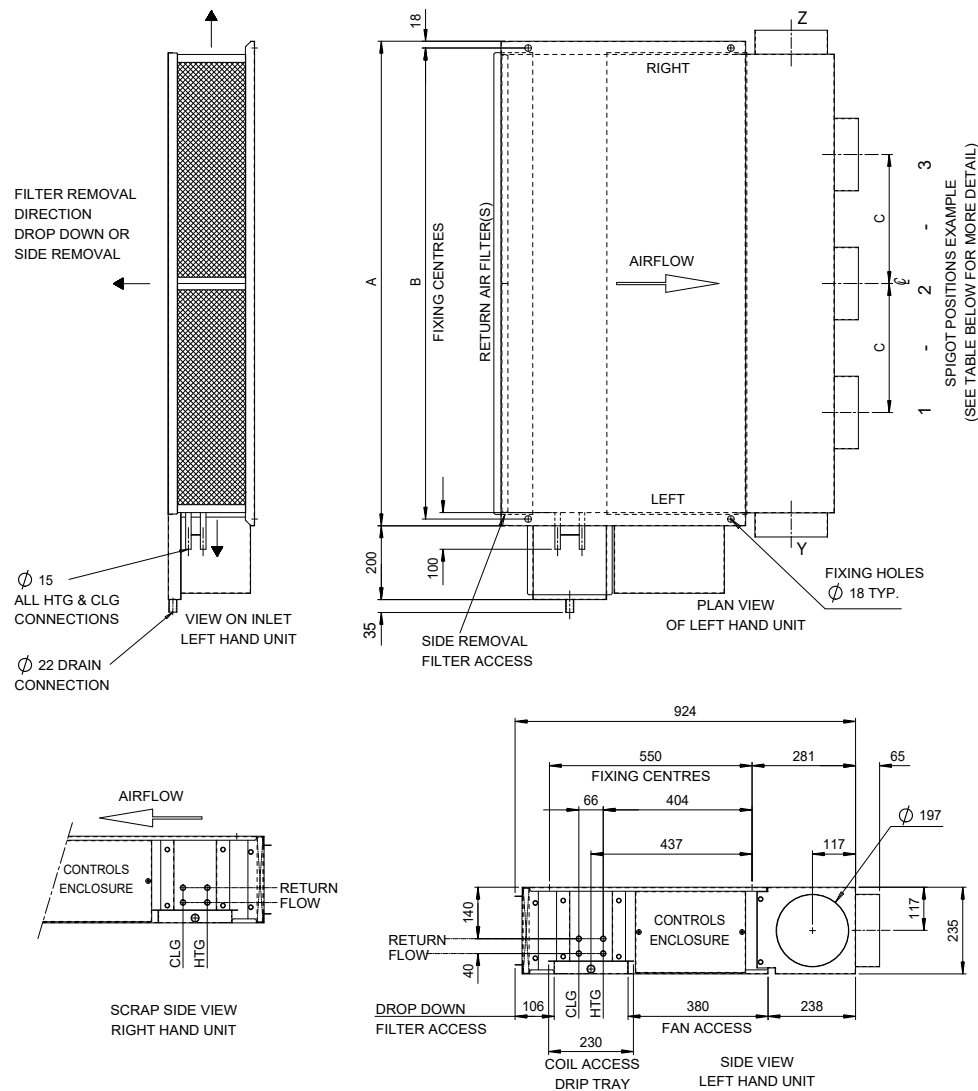

Units are handed looking against the direction of airflow, ie: looking into the discharge of the unit, with the unit in its installed orientation. General arrangement detail shows a fan coil with left hand coil connections.

Spigot positions are identified from left to right when looking into the discharge, with the unit in its installed orientation. Spigot positions are regardless of coil tail handings.

Model Size	Dimensions mm		Spigot pitch	Spigot positions	Weight	Coil volume ltrs	
	A	B	C	$\varnothing 197$	kg.	Clg.	Htg.
04/1	565	528	250	Y-1-2-Z	28	1.00	0.12
06/1	715	678	350	Y-1-2-Z	33	1.25	0.15
08/1	915	878	350	Y-1-2-Z	39	1.60	0.20
08/2	915	878	350	Y-1-2-Z	46	1.60	0.20
10/1	1115	1078	350	Y-1-2-3-Z	45	2.00	0.24
10/2	1115	1078	350	Y-1-2-3-Z	52	2.00	0.24
12/2	1315	1278	350	Y-1-2-3-Z	58	2.40	0.31
14/2	1515	1478	350	Y-1-2-3-4-Z	65	2.75	0.35
14/3	1515	1478	350	Y-1-2-3-4-Z	65	2.75	0.35
16/2	1715	1678	350	Y-1-2-3-4-Z	70	3.15	0.40
16/3	1715	1678	350	Y-1-2-3-4-Z	70	3.15	0.40
18/3	1915	1878	350	Y-1-2-3-4-5-Z	75	3.50	0.45
18/4	1915	1878	350	Y-1-2-3-4-5-Z	87	3.50	0.45

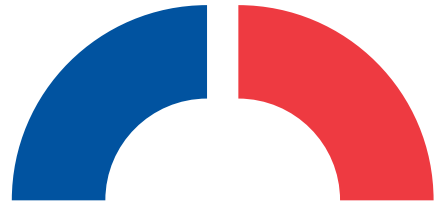

**Expand your
knowledge.**

**Attend our approved
CPD courses.**



Diffusion invite you to expand your knowledge within the Heating, Ventilating and Air Conditioning industry by attending our **FREE Continued Professional Development Courses (CPD).**



Attending Continued Professional Development courses helps expand your company's knowledge whilst proactively enhancing your professional capabilities. We invite you to expand your knowledge by attending our course which is held online for your convenience.

CPD Course Title: Understanding Heating, Ventilating and Air Conditioning

What you can expect to learn on this 1 hour course:

- Understanding the concept of air conditioning
- Gain an understanding of fan coil units including the different types, benefits, constraints and components
- The difference between EC/DC and AC motor technology
- An understanding of Specific Fan Power (SFP) and why it is important
- Control options and systems for different sized buildings
- Application guidance
- Ducting and the importance of Noise Ratings (NR)
- The process from product selection, design and installation

For full details and to book a CPD, please visit
www.diffusion-group.com/cpd or call +44(0)20 8783 0033



Case **studies.**

Discover some of the landmark buildings our products have been installed in.



The Shard Building

The Shard, Southwark's stunning skyscraper, created entirely of glass in the heart of London also benefits from Diffusion products that create occupant comfort all year round. Over 2,100 fan coil units were supplied to fulfill the complex needs of this stunning building. The tower has 61 habitable floors encompassing a mixture of premium office space, luxury apartments, a hotel, restaurants and retail spaces a spa and the phenomenally popular viewing gallery.



The Walkie Talkie Building

The iconic Walkie-Talkie building also known as 20 Fenchurch, the fifth tallest building in London at 525 ft benefits from 2000 Diffusion fan coil units. The specification was for low SFP's of 0.19 W/l/s, Diffusion exceeded the expectation providing units with SFP's of just 0.17 W/l/s.



One Bishopsgate Plaza Building

The spectacular 41 story building at One Bishopsgate Plaza in London benefits from almost 1,000 Diffusion fan coil units. These serve a variety of purposes in this impressive building. A 380 seat ballroom, a 5* hotel, shops, restaurants and luxury residential apartments that benefit from impressive views across London. Energy efficiency and thermal comfort were key requirements for this stunning project.

For full details please visit www.diffusion-group.com/cpd or call +44(0)20 8783 0033

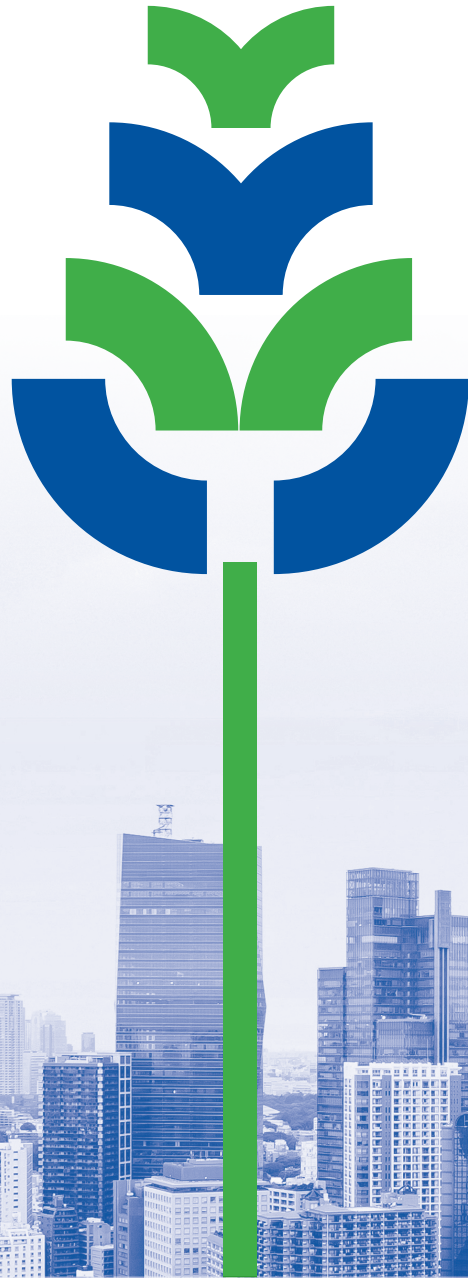

**Helping you build
your project and a
sustainable future.**



Working harder and smarter, together to ensure a **brighter future for our planet.**

Diffusion has over 60 years experience specialising in fan coil design and manufacture and is trusted by countless businesses across the construction supply chain.



UK
manufactured

We are critically aware of the need for a low carbon footprint and make consistent efforts to achieve this. As a UK manufacturer ourselves, we make every effort to source **our materials from UK manufacturers** and suppliers and continuously search for new and innovative ways to lower our carbon emissions.

Utilising our in-house technical and development capability allows continuous product evolution. Close collaboration with our suppliers and our customers helps us to reduce waste and improve the overall energy efficiency performance of our products. **During every design stage of our new modular 235 fan coil range, sustainability was considered.** Emphasis was to optimise the material content and selecting the lowest carbon motors available across the range. This resulted in smaller units, utilising less materials, reducing from start to finish the volume of materials transported, minimising the carbon footprint and lowering running costs per unit size.



Committed to a cleaner, **healthier future.**

Diffusion is focussed on playing our part to help the construction industry meet the **Net-Zero build environment by 2050.**
Diffusion is part of the Volution Group who have ambitious plans for sustainability across the group www.volutiongroupplc.com

Diffusion



We're here to help

Diffusion

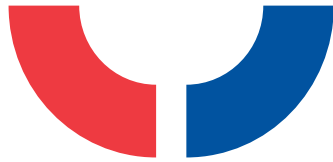

**We'd love to hear from you and help
you through every step of your project.**

To find out how we can help contact us today on
cooling@diffusion-group.com or call **+44 (0) 20 8783 0033**

Diffusion

HL235/0323.1